

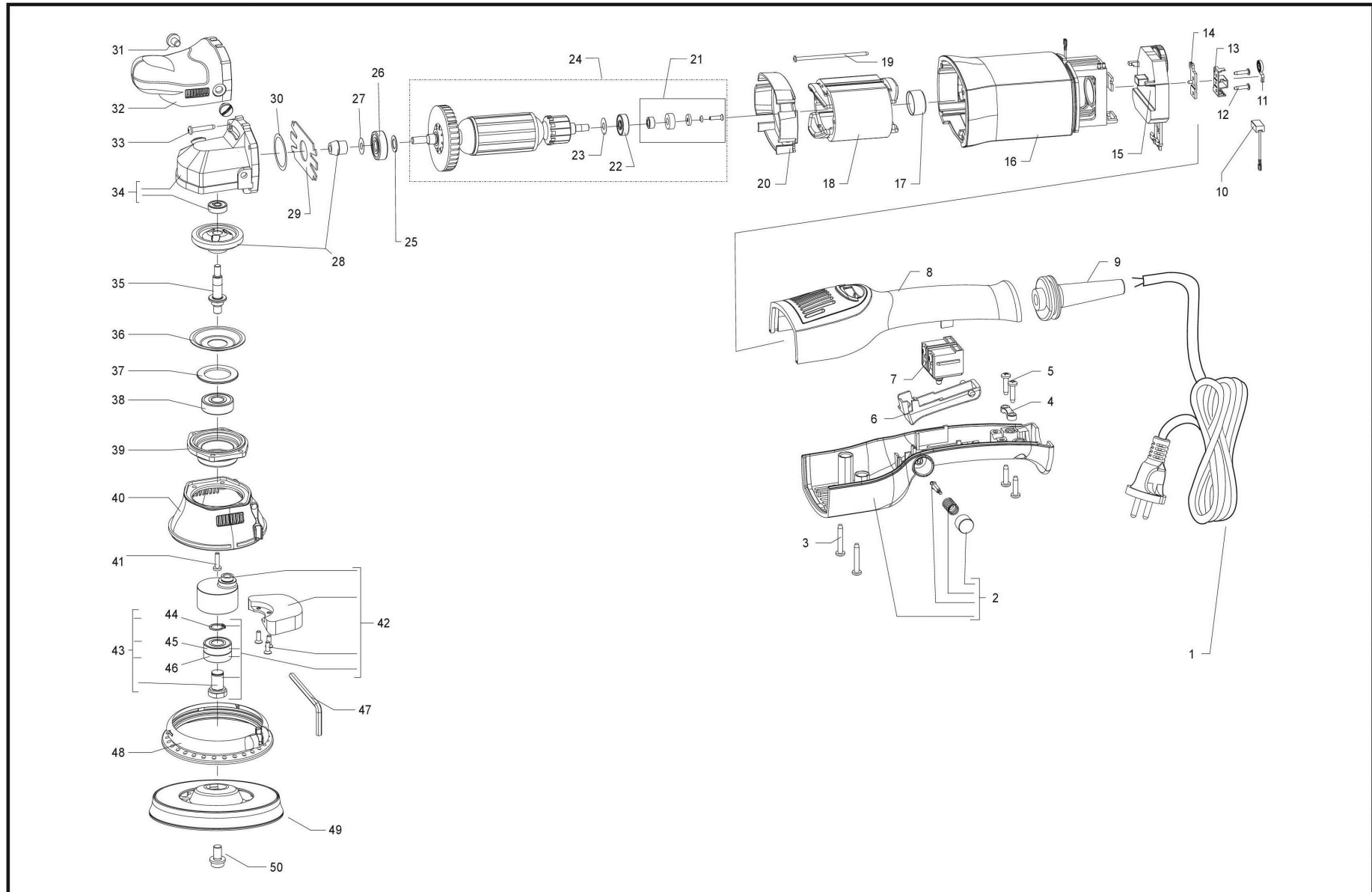















































RUPES®LUCIDATRICE ROTORBITALI
RANDOM-ORBITAL POLISHER**LHR15ES**



Point	Code	Beschreibung
001	9C2X0,8VUS9	CAVO 2x18AWG spina AMERICANA polarizzata R21 9mt.
001	9C2X1,0NAU9FOR	KABEL 2X1 (Stecker Australien) H07RN-F mt.9

	Point	Code	Beschreibung
	001	9C2X1,25VJA9	KABEL 2x1,25 (Stecker JAPAN) mt.9
	001	9C2X1,0R404FOR	KABEL 2X1 (Stecker D4) H07RN-F mt.4 mit Gabel (nur Schweiz)
	001	9C2X1,0N489	KABEL 2X1 (Stecker Schuko d4,8) mt.9 H07RN-F FLEX
	002	44.285/C	KOMPLETT UNTERE HANDGRIFF (blocco a/c)
	003	9.552	SCHRAUBE 3,9x25 (7x1") T.C.C.
	004	442.55	KABELKLEMME
	005	9.660	SCHRAUBE 3,9x16 (7x5/8") T.C.C.
	006	38.286	SCHALTER TASTE (Klemme Offen/Geschloss)
	007	45.284/UL	SCHALTER 8(8) max 250V
	007	45.284/UL	SCHALTER 8(8) max 250V
	008	441.285/E	OBEN HANDGRIFF F R ELEKTRONIK
	009	42.290	KABELSCHUTZ
	010	47.105/10	BLISTER MIT 10 STK. BUERSTEN BA215
	011	461.105	FEDER BUERSTENHALTER BA21 BRUNIERT
	012	9.551	SCHRAUBE 2,9x13 (4x1/2") T.C.C.
	013	46.105	BUERSTENHALTER BA215-LH18ENS

	Point	Code	Beschreibung
	014	462.105	B RSTENHALTER PLATTE
	015	400.246/60HZ/C	ELEKTRONIKMODUL
	015	400.246/C	ELEKTRONIKMODUL
	016	31.284	MOTOR BLOCK
	016	31.284/UL	MOTOR BLOCK (UL Material)
	017	268.105	LAGER KAPPE
	018	2.245/100S	STATOR (V.100)
	018	2.245/120S	STATOR (V.120)
	018	2.245/230S	STATOR (V.230)
	019	9.787	SCHRAUBE 2,9x70 T.C.C.
	020	73.284	LUFT SCHOTT
	021	405.322/C	KOMPLETTE MAGNET
	022	9.14/10	LAGER 626 ZZ

	Point	Code	Beschreibung
	023	9.318	STAHL UNTERLEGSCHIEBE d15 x 6,1 s 0,15
	024	1.245/100S/C	ROTOR (V.100-110)
	024	1.245/120S/C	ROTOR (ARMATURE) 120V
	024	1.245/230S/C	ROTOR (V.230)
	025	9.298	STAHL UNTERLEGSCHIEBE d15 x 9,1 s 0,5
	026	9.187/10	LAGER 629 2BRS R66 FA227 ERI
	027	9.318	STAHL UNTERLEGSCHIEBE d15 x 6,1 s 0,15
	028	50.245	RITZEL KRANZ
	029	351.105	MOTOR BLOCK KLEINE DECKEL
	030	9.364	STAHL UNTERLEGSCHIEBE d25,9x21 s 0,1
	031	812.91	SCHRAUBE M8 x 15 T.C.IN NYLON A.T.
	032	816.246/C	KOMPLETT FRONTALGEHÄUSE
	033	9.679	SCHRAUBE 4,2x25 (8x1") T.C.C.

	Point	Code	Beschreibung
	034	32.245/C/31	GETRIEBEKASTEN MIT TASTE
	035	51.245	SPINDEL WELLE
	036	35.105	FLANSCHDECKEL BA21
	037	54.245	DISTANZSTUECK GETRIEBEKASTEN
	038	9.184/10	LAGER 6201 2BRS R66 FA227 ERI
	039	33.245	FLANSCH
	040	65.245	SCHUTZKAPPE
	041	9.835	SCHRAUBE 3,9x 9,5 T.C.C. GLANZDRUECKEN
	042	58.196N/C	ECCENTRIC ASSEMBLY
	043	56.245N/C	KOMPLETT VORSCHLAGHAMMER ZAPFEN
	044	9.102	SEEGER d 12 TIPO E DIN 471 CR3 PHOSPHATIERT
	046	9.182/10	LAGER NSK 6001 DDWCM J NS75Z
	047	9.1395	INBUSSCHL SSEL 5mm

	Point	Code	Beschreibung
	048	651.246	GUMMI KASTEN
	050	9.715	SCHRAUBEM8 x 16 T.B VERZINKT MIT UNTERLEGSCHIEBE