

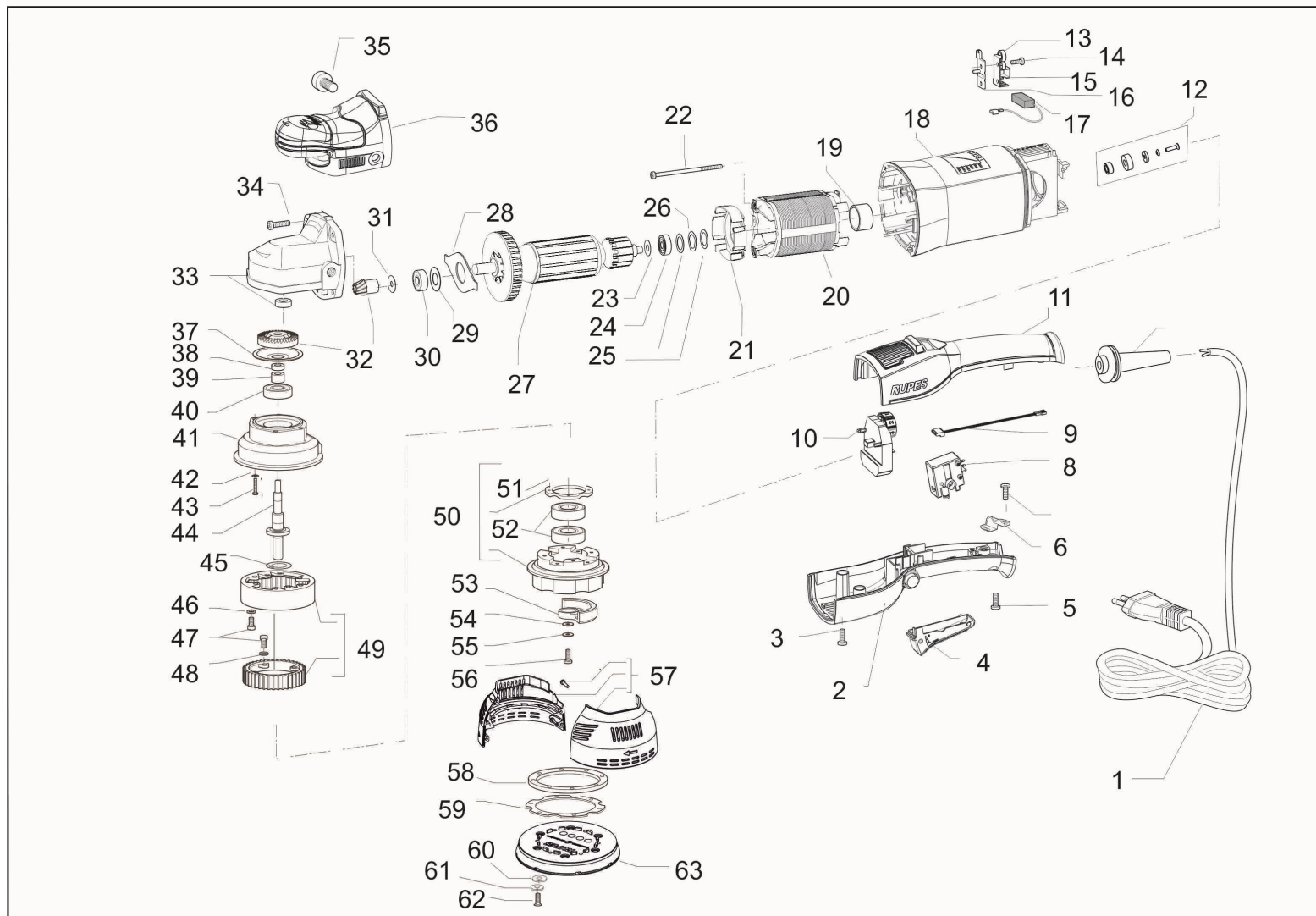

















































RUPESLUCIDATRICE ROTOECCENTRICA
GEAR DRIVEN POLISHER**LK900E**











Point	Code	Beschreibung
001	9C2X1,0NGB9FOR	KABEL 2X1 (Stecker UK) mit Gabel H07RN-F ZENTRALE METALL STECKER mt.9
001	9C2X1,0NAU9FOR	KABEL 2X1 (Stecker Australien) H07RN-F mt.9
001	9C2X1,0R409FOR	KABEL 2X1 (Stecker D4) H07RN-F mt.9 mit Gabel (nur Schweiz)
001	9C2X1,0N489FOR	KABEL 2X1 (Stecker Schuko d4,8) mt.9 H07RN-F FLEX
001	9C2X1,25VJA9FOR	KABEL 2x1,25 (Stecker JAPAN) mt.9 mit Gabel
002	44.374/C	KOMPLETT UNTERE HANDGRIFF
002	44.374/C	KOMPLETT UNTERE HANDGRIFF









	Point	Code	Beschreibung
	003	9.552	SCHRAUBE 3,9x25 (7x1") T.C.C.
	003	9.552	SCHRAUBE 3,9x25 (7x1") T.C.C.
	004	38.374/C	SCHALTER TASTE
	004	38.374/C	SCHALTER TASTE
	005	9.650	SCHRAUBE 3,5x19 (6x3/4") T.C.C.
	005	9.650	SCHRAUBE 3,5x19 (6x3/4") T.C.C.
	006	442.55	KABELKLEMME
	006	442.55	KABELKLEMME
	007	9.660	SCHRAUBE 3,9x16 (7x5/8") T.C.C.
	007	9.660	SCHRAUBE 3,9x16 (7x5/8") T.C.C.
	008	45.372	FORTLAUFEN SCHALTER
	008	45.372	FORTLAUFEN SCHALTER
	009	408.374/C	KABELSTRANG
	009	408.374/C	KABELSTRANG
	010	400.379/60HZ/C	ELEKTRONIKMODUL 60Hz LK900E
	010	400.379/60HZ/C	ELEKTRONIKMODUL 60Hz LK900E
	010	400.379/C	ELEKTRONIKMODUL 50Hz LK900E
	010	400.379/C	ELEKTRONIKMODUL 50Hz LK900E
	011	441.374/C	IMPUGNATURA GOMMATA SUPERIORE COMPLETA
	011	441.374/C	IMPUGNATURA GOMMATA SUPERIORE COMPLETA
	012	405.322/C	KOMPLETTE MAGNET
	012	405.322/C	KOMPLETTE MAGNET

	Point	Code	Beschreibung
	013	461.105	FEDER BUERSTENHALTER BA21 BRUNIERT
	013	461.105	FEDER BUERSTENHALTER BA21 BRUNIERT
	014	9.551	SCHRAUBE 2,9x13 (4x1/2") T.C.C.
	014	9.551	SCHRAUBE 2,9x13 (4x1/2") T.C.C.
	015	46.105	BUERSTENHALTER BA215-LH18ENS
	015	46.105	BUERSTENHALTER BA215-LH18ENS
	016	462.105	BUERSTENHALTER PLATTE
	016	462.105	BUERSTENHALTER PLATTE
	017	47.105/10	BLISTER MIT 10 STK. BUERSTEN BA215
	017	47.105/10	BLISTER MIT 10 STK. BUERSTEN BA215
	019	268.105	LAGER KAPPE
	019	268.105	LAGER KAPPE
	020	2.374/230S/C	STATOR (230V) LK900E
	020	2.374/230S/C	STATOR (230V) LK900E
	022	9.787	SCHRAUBE 2,9x70 T.C.C.
	022	9.787	SCHRAUBE 2,9x70 T.C.C.

	Point	Code	Beschreibung
	023	9.318	STAHL UNTERLEGSCHIEBE d15 x 6,1 s 0,15
	023	9.318	STAHL UNTERLEGSCHIEBE d15 x 6,1 s 0,15
	024	9.14/10	LAGER 626 ZZ M5MTLY121/LY342
	024	9.14/10	LAGER 626 ZZ M5MTLY121/LY342
	025	9.306	STAHL UNTERLEGSCHIEBE d18 x 12,3 s 0,3
	025	9.306	STAHL UNTERLEGSCHIEBE d18 x 12,3 s 0,3
	026	9.204	UNTERLEGSCHIEBE LMKAS 19 A .d18,8x13,2 s 0,2
	026	9.204	UNTERLEGSCHIEBE LMKAS 19 A .d18,8x13,2 s 0,2
	027	1.379/230S/C	ROTOR (230V) LK900E
	027	1.379/230S/C	ROTOR (230V) LK900E
	027	1.379/120S/C	ROTOR (120V) LK900E
	027	1.379/120S/C	ROTOR (120V) LK900E
	028	35.374/C	BLATTFEDER
	028	35.374/C	BLATTFEDER
	029	9.298	STAHL UNTERLEGSCHIEBE d15 x 9,1 s 0,5
	029	9.298	STAHL UNTERLEGSCHIEBE d15 x 9,1 s 0,5
	030	9.187/10	LAGER 629 2BRS R66 FA227 ERI
	030	9.187/10	LAGER 629 2BRS R66 FA227 ERI

	Point	Code	Beschreibung
	031	9.218	STAHL UNTERLEGSCHEIBE d20 x 8,1 SP 0,1
	031	9.218	STAHL UNTERLEGSCHEIBE d20 x 8,1 SP 0,1
	032	50.105	RITZEL KRANZ
	032	50.105	RITZEL KRANZ
	033	32.379/C	SCATOLA INGRANAGGI LK900E CON CUSCINETTO
	033	32.379/C	SCATOLA INGRANAGGI LK900E CON CUSCINETTO
	034	9.679	SCHRAUBE 4,2x25 (8x1") T.C.C.
	034	9.679	SCHRAUBE 4,2x25 (8x1") T.C.C.
	036	815.379/C	LK900E FRONTGEHAEUSE KPL.
	036	815.379/C	LK900E FRONTGEHAEUSE KPL.
	037	35.105	FLANSCHDECKEL BA21
	037	35.105	FLANSCHDECKEL BA21
	038	54.116	DISTANZSTUECK
	038	54.116	DISTANZSTUECK
	039	541.116	DISTANZSTUECK
	039	541.116	DISTANZSTUECK
	040	9.190/10	BEARING 6201 DDW1CM D ENSS6

	Point	Code	Beschreibung
	040	9.190/10	BEARING 6201 DDW1CM D ENSS6
	042	9.329	GEZAHNT UNTERLEGSCHIEBE
	042	9.329	GEZAHNT UNTERLEGSCHIEBE
	043	9.628	SCHRAUBE M4 x 35 T.G.S. GLANZDRUECKEN
	043	9.628	SCHRAUBE M4 x 35 T.G.S. GLANZDRUECKEN
	044	51.379	STAHL SPINDEL DORN
	044	51.379	STAHL SPINDEL DORN
	046	9.219	Unterlegscheibe d 4x9X0,8
	046	9.219	Unterlegscheibe d 4x9X0,8
	048	9.219	Unterlegscheibe d 4x9X0,8
	048	9.219	Unterlegscheibe d 4x9X0,8
	049	52.379/C	RAEDDERPAAR FUR LK900E
	049	52.379/C	RAEDDERPAAR FUR LK900E
	050	331.379/C	KOMPLETT RAEDERPAAR BECKER
	050	331.379/C	KOMPLETT RAEDERPAAR BECKER
	052	9.190/10	BEARING 6201 DDW1CM D ENSS6
	052	9.190/10	BEARING 6201 DDW1CM D ENSS6
	053	57.379	GEGENGEWICHT
	053	57.379	GEGENGEWICHT
	054	9.1807	UNTERLEGSCHIEBE d 15x5,5x1,6 UNI 6593
	054	9.1807	UNTERLEGSCHIEBE d 15x5,5x1,6 UNI 6593

	Point	Code	Beschreibung
	055	9.1843	RANELLA CONTACT d 5,1 x D 12 ZINC.
	055	9.1843	RANELLA CONTACT d 5,1 x D 12 ZINC.
	056	9.616	SCHRAUBE M5 x 14 TC + C/D STAHL 8.8 T.P.
	056	9.616	SCHRAUBE M5 x 14 TC + C/D STAHL 8.8 T.P.
	057	65.379/C	ABECKUNG KPL.
	057	65.379/C	ABECKUNG KPL.
	058	70.379	FILZHUT RING LK
	058	70.379	FILZHUT RING LK
	062	9.614	SCHRAUBE M4 x 12 T.C.C. d7,7 BRN 8.8
	062	9.614	SCHRAUBE M4 x 12 T.C.C. d7,7 BRN 8.8
	063	981.089/C	CONF. DA 1 PLATORELLO Ø 150mm-6" VELCRO per LK900E/DLX
	063	981.089/C	CONF. DA 1 PLATORELLO Ø 150mm-6" VELCRO per LK900E/DLX
	063	980.037	Ø 125mm-5" KLETTSTUETZTELLER FUER LK900E
	063	980.037	Ø 125mm-5" KLETTSTUETZTELLER FUER LK900E
	2.*		
	2.*		
	2.*		
	2.*		
	2.*		
	2.*		
	2.*		
	2.*		
	306	9.306	STAHL UNTERLEGSCHIEBE d18 x 12,3 s 0,3
	306	9.306	STAHL UNTERLEGSCHIEBE d18 x 12,3 s 0,3